

CONFIDENTIAL
 THIS DOCUMENT CONTAINS CONFIDENTIAL AND PROPRIETARY INFORMATION OF DEUBLIN COMPANY. COPYING, USE, TRANSMISSION, DISTRIBUTION, AND DISCLOSURE ARE SUBJECT TO THE TERMS AND CONDITIONS CONTAINED IN YOUR AGREEMENT WITH DEUBLIN COMPANY. ALL RIGHTS RESERVED.

NOTES:
 △ - TOTAL FLEX

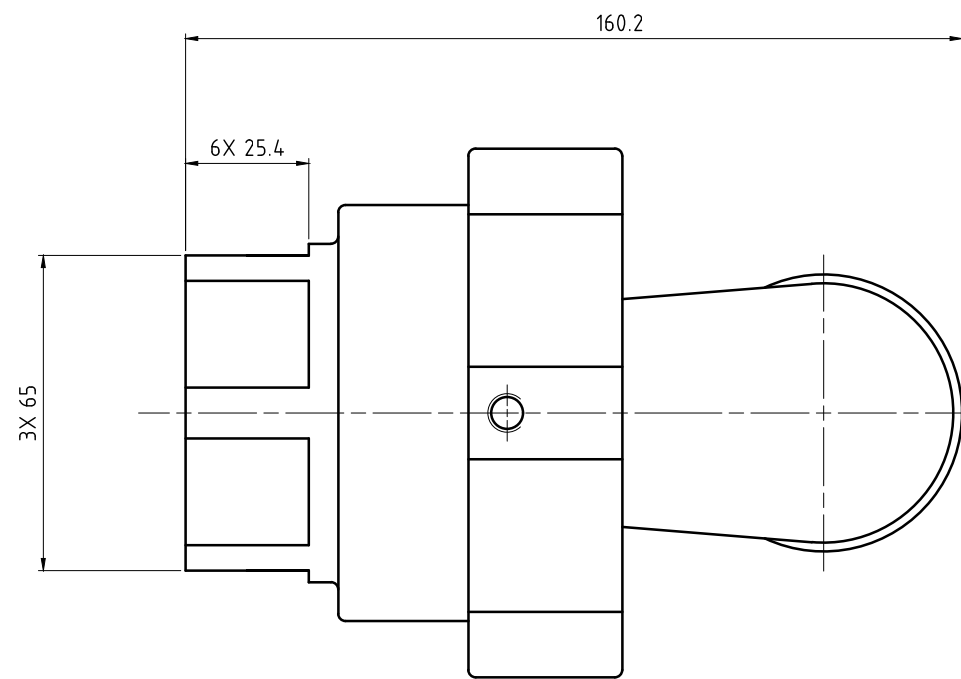
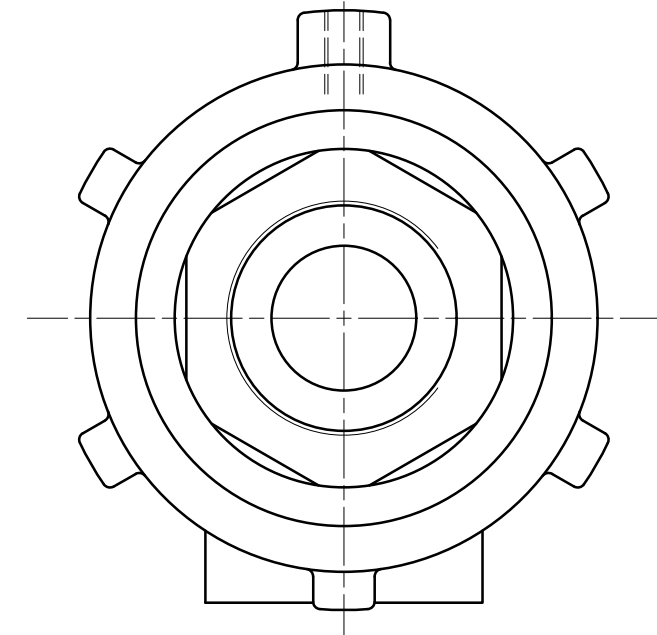
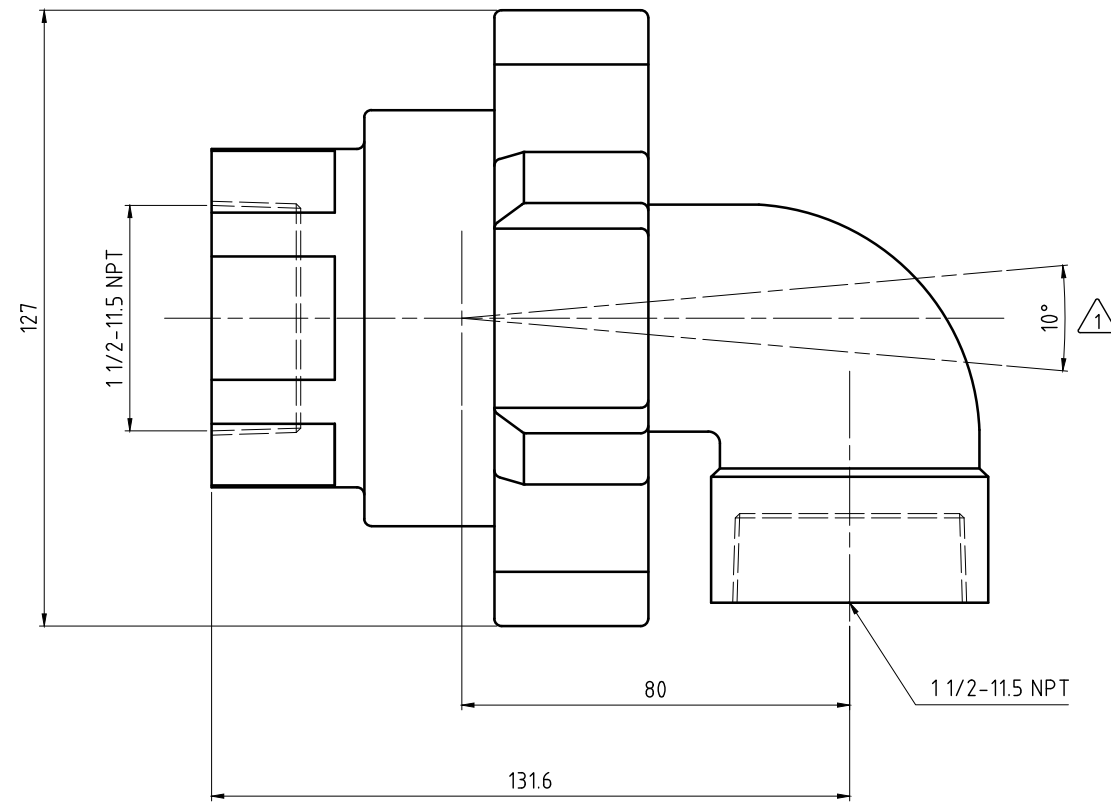
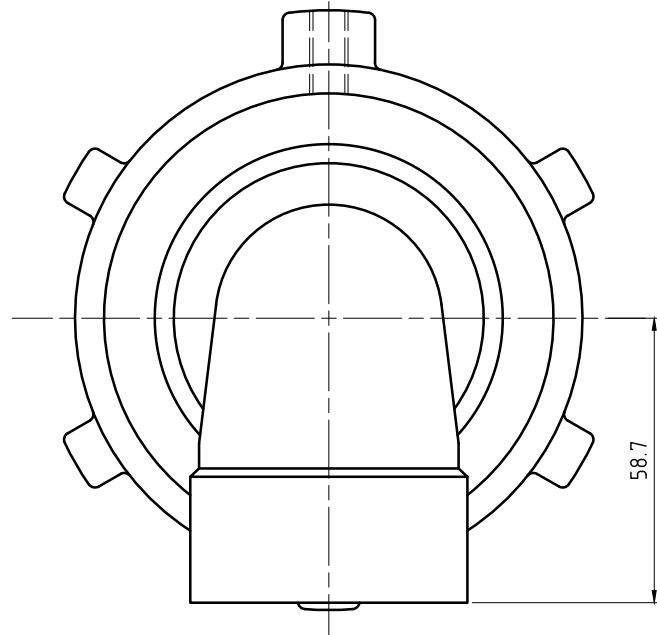

		PROJECTION:	SCALE: 1:1
			MATERIAL: INTERFACE CONTROL DRAWING
	DATE	NAME	TITLE:
	DRN. 01/09/13	N. Reyna	SELF ALIGN SWIVEL JOINT
	ENGR. 01/09/13	L. Freed	
	APPD.		
UNLESS SPECIFICALLY TOLERANCED, ALL DIMENSIONS ARE CONSIDERED REFERENCE			NO. BE-32007-24-24
ISSUE	MODIFICATION	ECO	DATE
			SIGN
			SHEET A2