

NOTES:

- 1 - USE INSTRUCTION MANUAL 040-554!
- SPINDLE BEARING ARRANGEMENT
- ROUNDED
- VENT

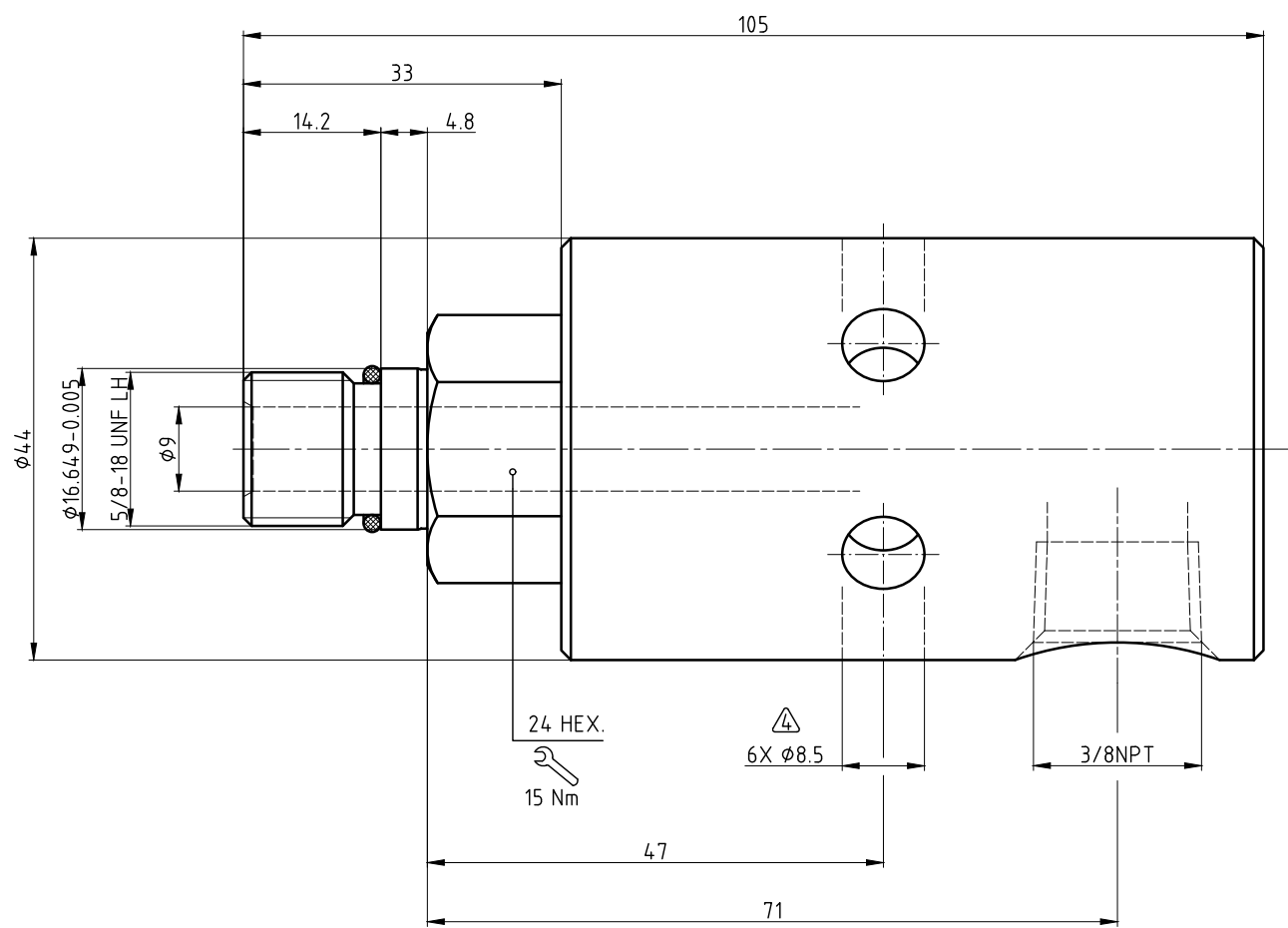

CUSTOMER'S INTERFACE

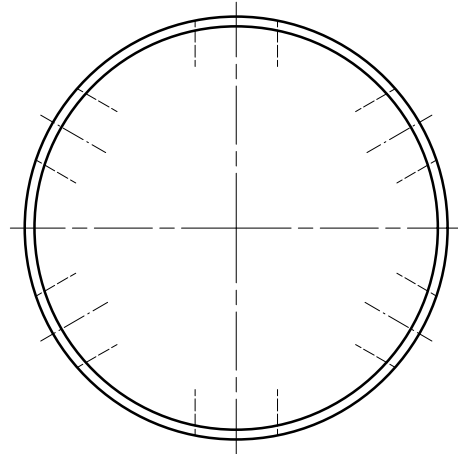
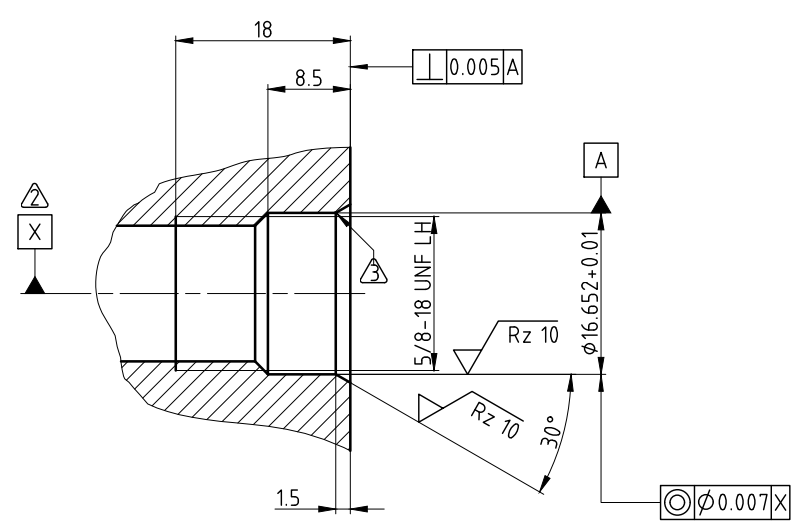

OPERATING DATA		
MEDIA	COOLANT	MQL
PRESSURE MAX.	70 bar	10 bar
SPEED MAX.	12000 min ⁻¹	12000 min ⁻¹
TEMPERATURE MAX.	70 °C	70 °C
FLOW RATE MAX.	82 l/min	2550 NI/min
DRY RUN	NO	

DEUBLIN
 Engineered for Performance

PROJECTION:

SCALE: 2:1

MATERIAL: INTERFACE CONTROL DRAWING

TITLE: DEUBLIN ROTATING UNION
 DEUBLIN Drehdurchführung

NO. 1116-090-059

SHEET A2

D	UPDATE TO MS	009514	05/10	CW
ISSUE	MODIFICATION	ECO	DATE	SIGN

UNLESS SPECIFICALLY TOLERANCED, ALL DIMENSIONS ARE CONSIDERED REFERENCE