

CONFIDENTIAL
 THIS DOCUMENT CONTAINS CONFIDENTIAL AND PROPRIETARY
 INFORMATION OF DEUBLIN COMPANY. COPYING, USE,
 TRANSMISSION, DISTRIBUTION, AND DISCLOSURE ARE SUBJECT
 TO THE TERMS AND CONDITIONS CONTAINED IN YOUR
 AGREEMENT WITH DEUBLIN COMPANY. ALL RIGHTS RESERVED.

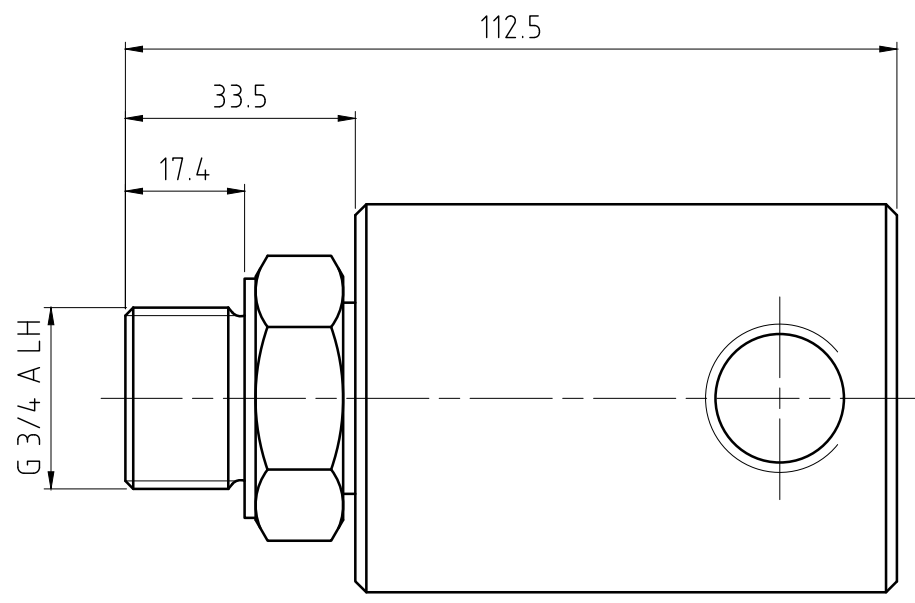
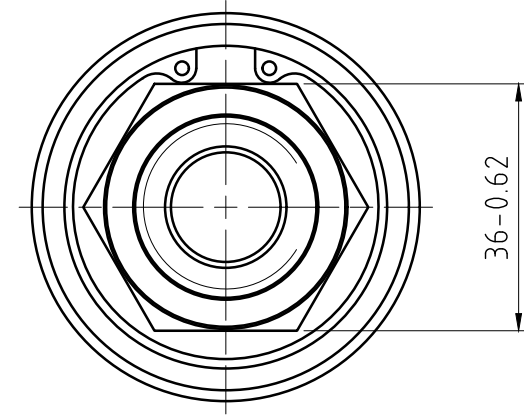
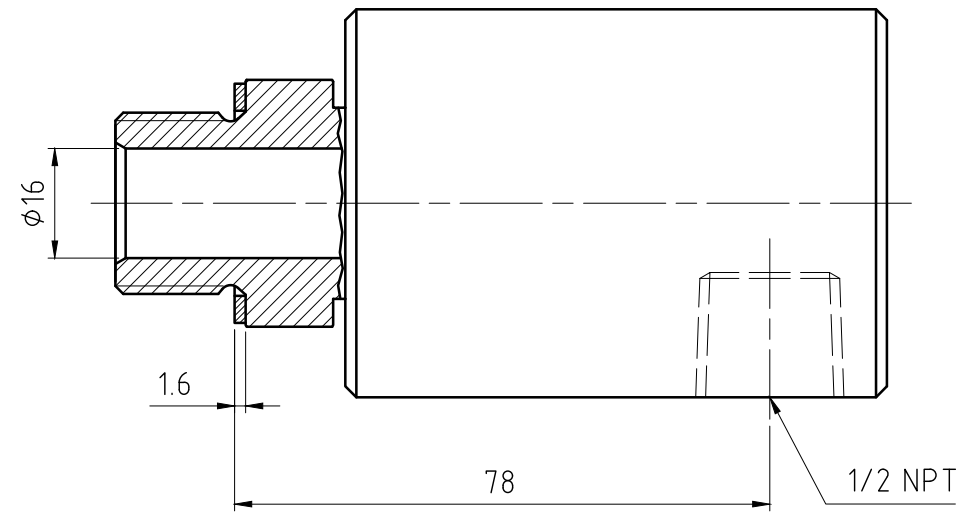
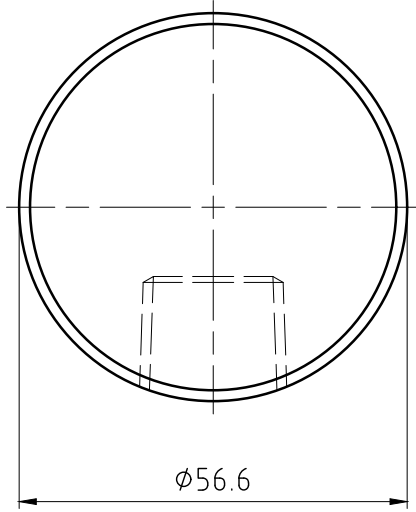

OPERATING DATA		
MEDIA	AIR/VACUUM/HYDRAULIC	
MAX AIR PRESSURE	150 PSI	10 bar
MAX VACUUM	28"Hg	6.7kPa
MAX HYDRAULIC PRESSURE	750 PSI	50 bar
MAX TEMPERATURE	250°F	121°C
MAX SPEED	3500 RPM	3500/MIN.

		PROJECTION:	SCALE: 1:1
			MATERIAL: INTERFACE CONTROL DRAWING
		DATE	NAME
		DRN. 07/24/12	N. Reyna
		ENGR. 07/24/12	T. Wilson
		APPD.	
		TITLE: DEUBLIN UNION	
		NO. 1205-000-022	
		SHEET A3	
ISSUE	MODIFICATION	ECO	DATE
			SIGN

UNLESS SPECIFICALLY TOLERANCED, ALL DIMENSIONS ARE CONSIDERED REFERENCE