

NOTES:

1 - WHEN ORDERING FROM DEUBLIN USE PART NUMBER 357-000-003.

2 - PLUG INSTALLED HAND TIGHT FROM FACTORY. IF PORT IS NOT UTILIZED, TIGHTEN BEFORE USE.

OPERATING DATA:
 WATER SERVICE
 150 PSI (10bar) MAX. WATER PRESSURE
 1500 RPM (1500/min) MAX. SPEED
 200°F (93°C) MAX. TEMPERATURE

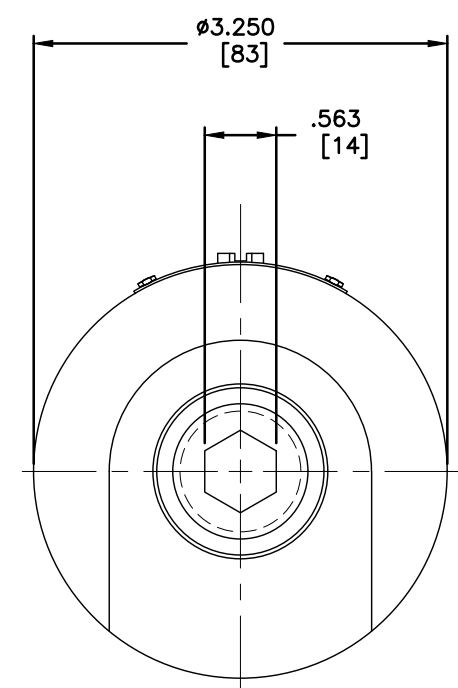
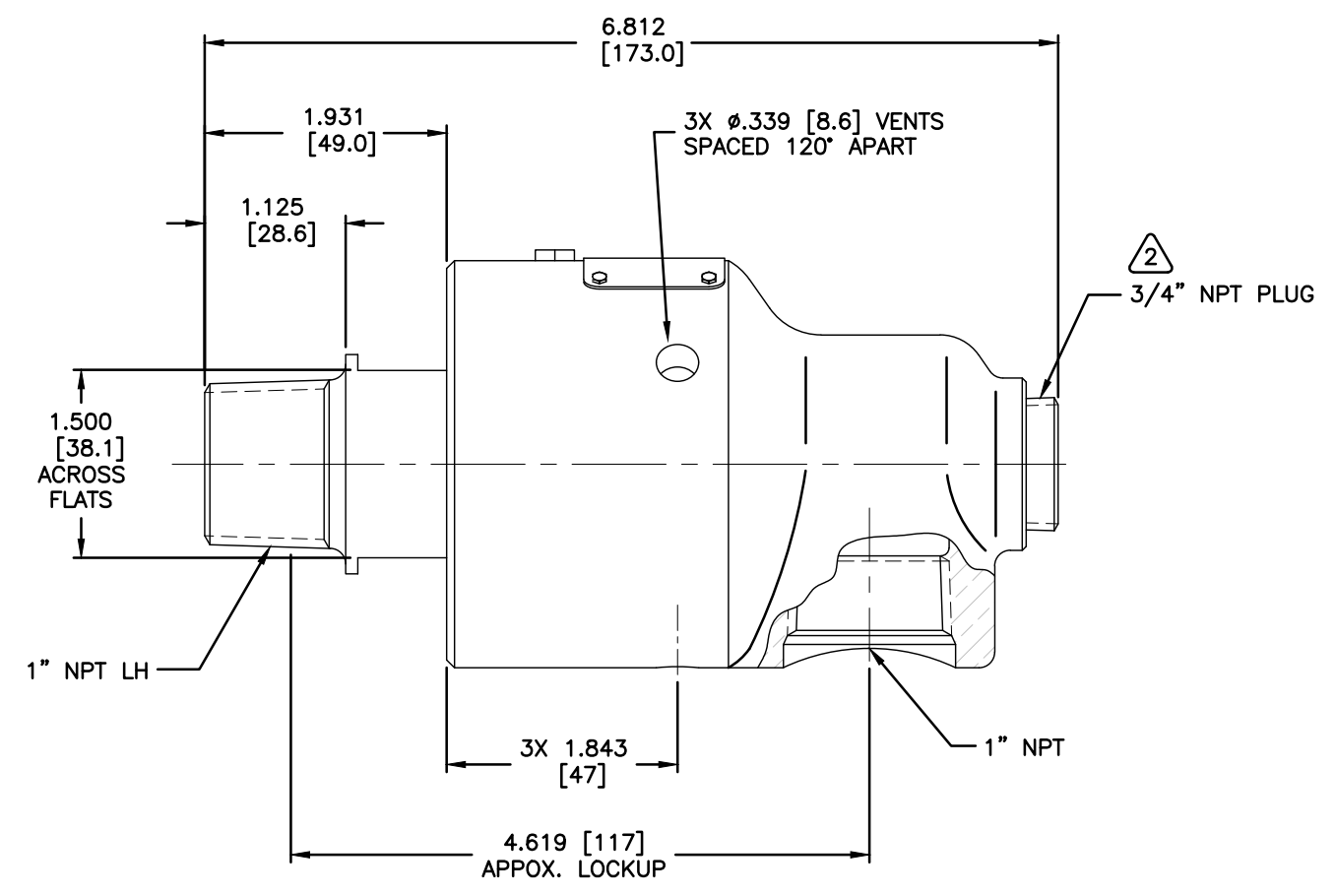
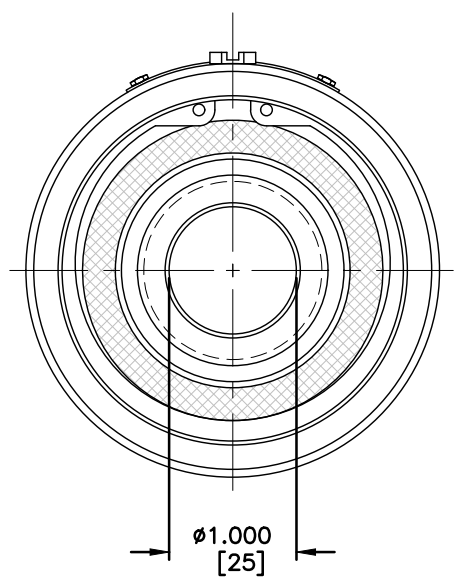
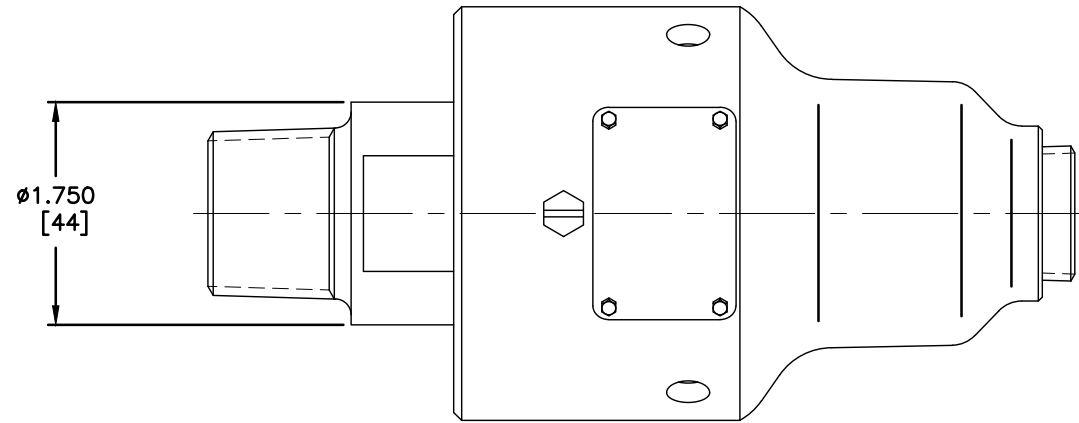

CONFIDENTIAL
 THIS DOCUMENT CONTAINS PROPRIETARY INFORMATION AND IS NOT TO BE TRANSMITTED, REPRODUCED, USED OR DISCLOSED TO ANYONE WITHOUT THE WRITTEN PERMISSION OF THE DEUBLIN COMPANY.

LET.	REVISION	ECO	DATE	SIGN

EQUIPMENT REF:
 ASSY/TEST FIXTURES REQUIRED:

SCALE	FULL	DWG SIZE	C
DRN	LMG	11/08/01	
ENGR			
APPD			

DEUBLIN COMPANY
 WAUKEGAN, ILLINOIS, U.S.A.
 TITLE: INTERFACE CONTROL DRAWING FOR UNION 357-000-003
 NO. 357-000-003-IC
 C.A.D DRAWING

UNLESS OTHERWISE SPECIFIED TOLERANCES ±.010. DIMENSIONS IN [] ARE IN MILLIMETERS.