

CONFIDENTIAL
 THIS DOCUMENT CONTAINS CONFIDENTIAL AND PROPRIETARY
 INFORMATION OF DEUBLIN COMPANY. COPYING, USE,
 TRANSMISSION, DISTRIBUTION, AND DISCLOSURE ARE SUBJECT
 TO THE TERMS AND CONDITIONS CONTAINED IN YOUR
 AGREEMENT WITH DEUBLIN COMPANY. ALL RIGHTS RESERVED.

NOTES:

- ① - PIPE SUPPLIED BY CUSTOMER. PIPE SIZE: 6.35mm
- ② - PIPE LENGTH.
- ③ - CONTACT DEUBLIN OR VISIT WWW.DEUBLIN.COM
FOR INSTRUCTION MANUAL: 040-550
- ④ - FITTING TO BE ASSEMBLED HAND-TIGHT, OR MAY BE SHIPPED UNASSEMBLED.
- ⑤ - GASKET THICKNESS.

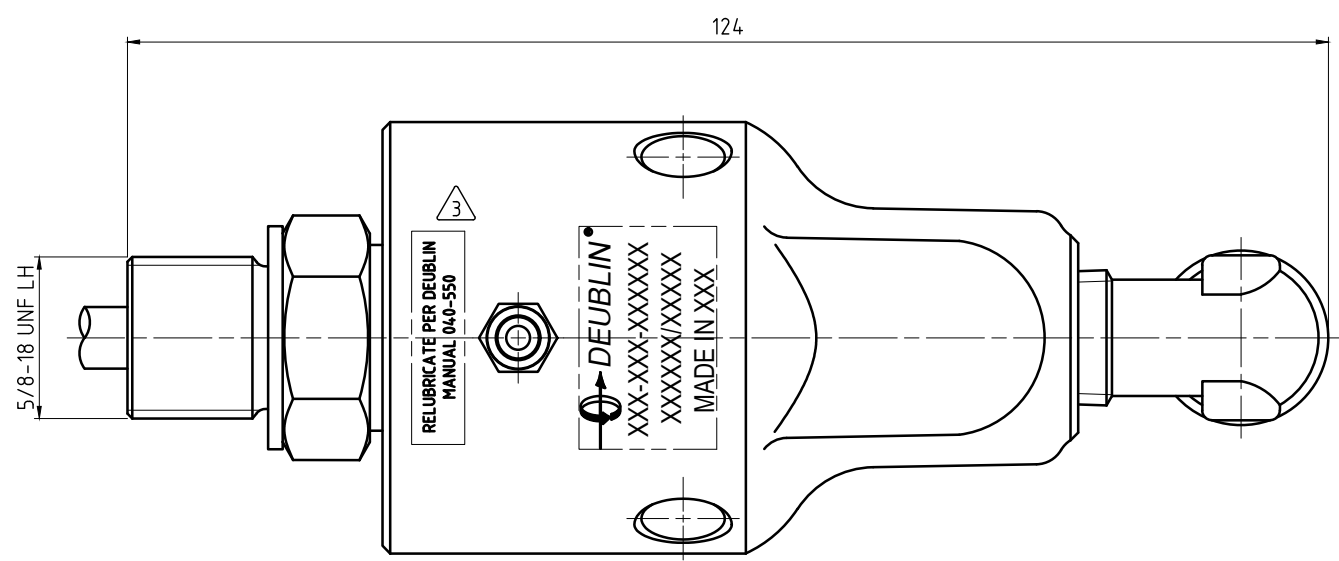
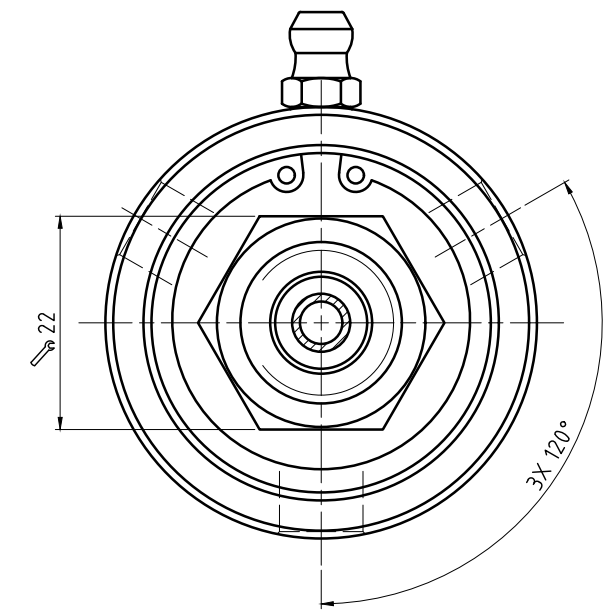
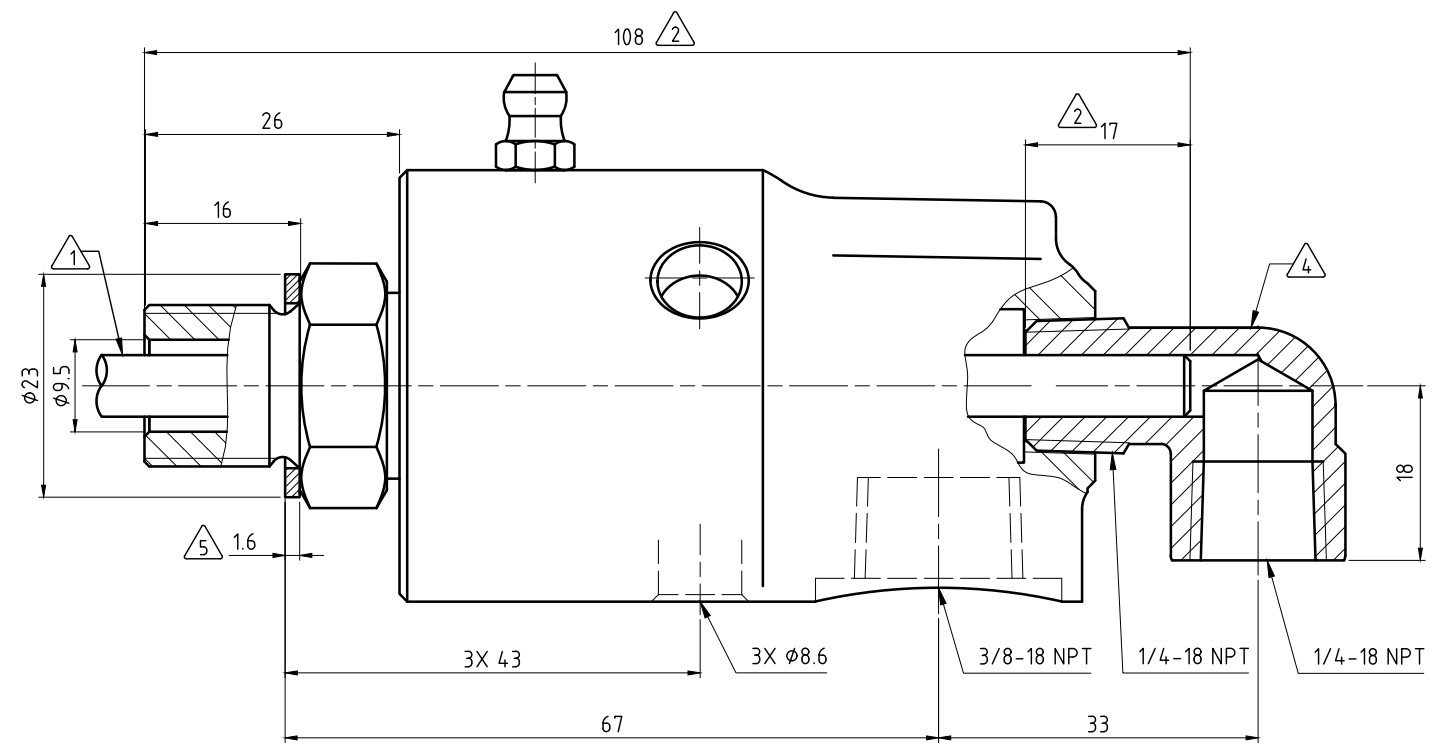
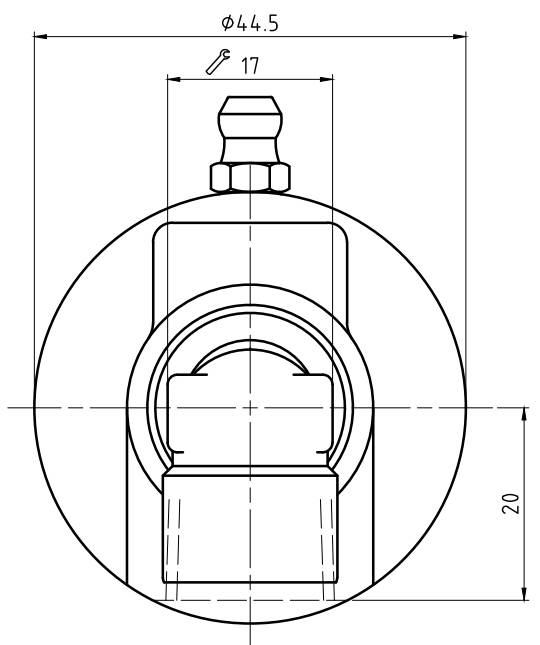

OPERATING DATA			
MEDIA	WATER	SATURATED STEAM (INTERMITTENT)	THERMAL OIL
PRESSURE MAX.	50 bar	1 bar	6.6 bar
SPEED MAX.	3500 min ⁻¹		
TEMPERATURE MAX.	120 °C		
DRY RUN (WITHOUT ANY MEDIA)	NO		
RECOMMENDED FILTRATION	60 micron		

DEUBLIN
HOERBIGER Rotary Solutions

PROJECTION:

SCALE: 2:1

MATERIAL: INTERFACE CONTROL DRAWING

TITLE: DEUBLIN UNION

NO. 57-000-004030

SHEET A2

DRN.	08/12/2020	MSveľecich
ENGR.	10/2/2020	RMKA
APPD.		

A	RELEASE	05/23/20	08/20	MTS
	ISSUE/MODIFICATION	ECO	DATE	SIGN

UNLESS SPECIFICALLY TOLERANCED, ALL DIMENSIONS ARE CONSIDERED REFERENCE