

CONFIDENTIAL
 THIS DOCUMENT CONTAINS CONFIDENTIAL AND PROPRIETARY
 INFORMATION OF DEUBLIN COMPANY. COPYING, USE,
 TRANSMISSION, DISTRIBUTION, AND DISCLOSURE ARE SUBJECT
 TO THE TERMS AND CONDITIONS CONTAINED IN YOUR
 AGREEMENT WITH DEUBLIN COMPANY. ALL RIGHTS RESERVED.

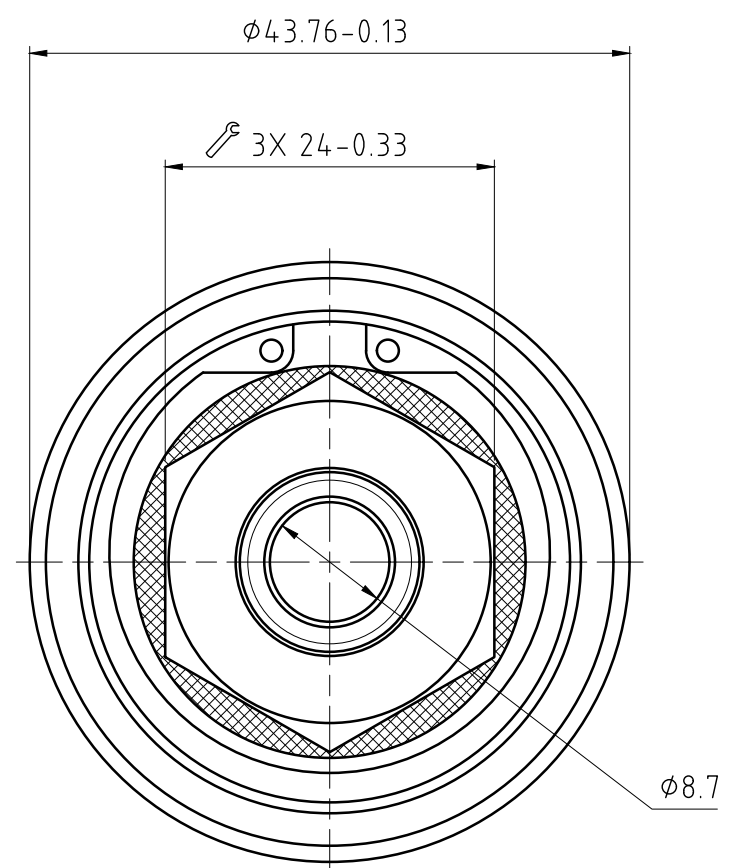
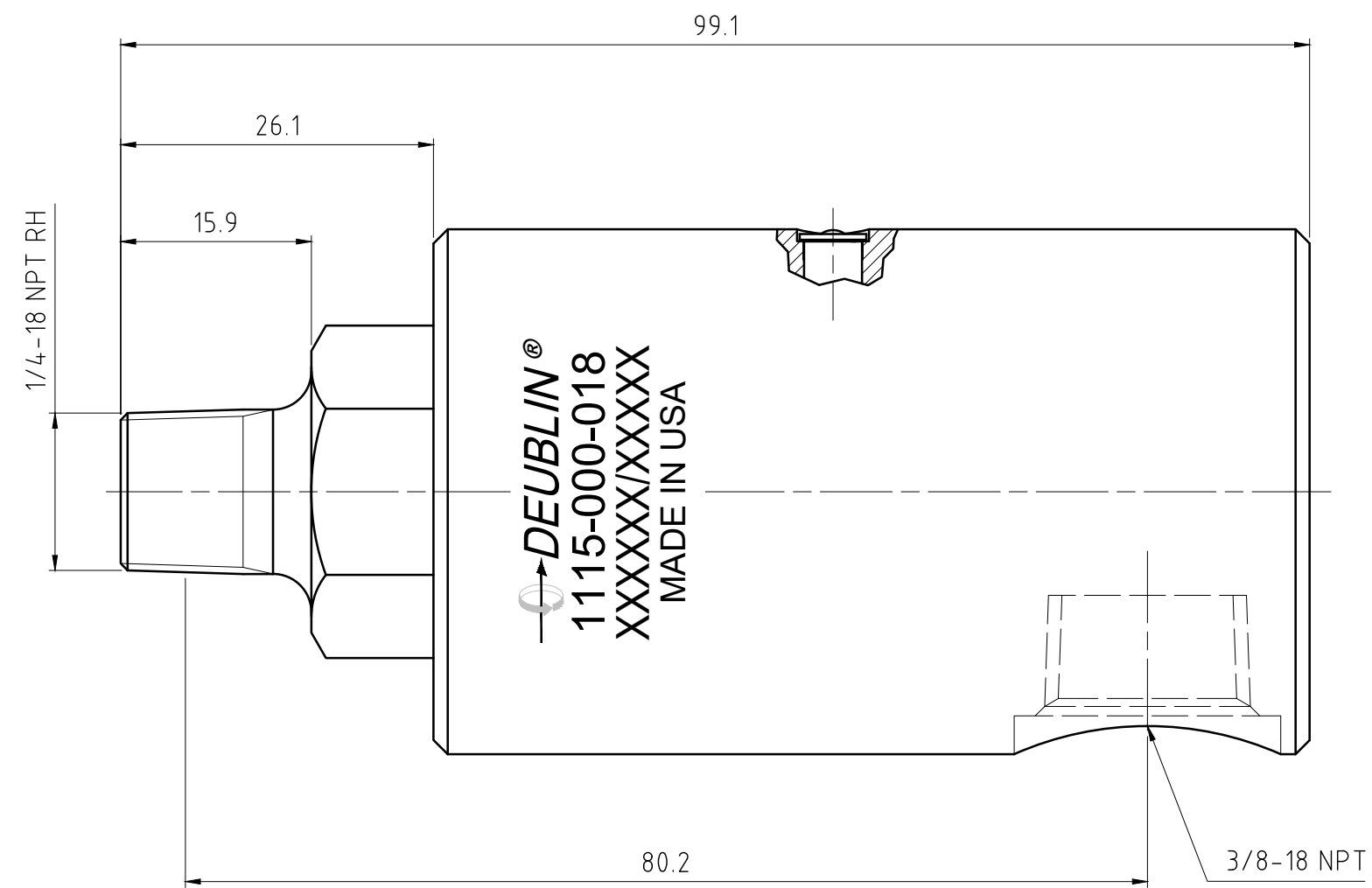

OPERATING DATA		
MEDIA	AIR & HYDRAULIC	
MAX AIR PRESSURE	150 PSI	10 bar
MAX VACUUM	28" Hg	6.7 kPa
MAX HYD. PRESSURE	500 PSI	34 bar
MAX SPEED	1500 RPM	1500/min
MAX TEMPERATURE	250°F	120°C

		PROJECTION:		SCALE: 2:1	
		MATERIAL:		INTERFACE CONTROL DRAWING	
		DATE	NAME	TITLE:	
		DRN. 11/16/18	N. Reyna	DEUBLIN UNION	
		ENGR. 11/16/18	T. Wilson		
		APPD.			
		UNLESS SPECIFICALLY TOLERANCED, ALL DIMENSIONS ARE CONSIDERED REFERENCE		NO. 1115-000-018	
ISSUE	MODIFICATION	ECO	DATE	SIGN	SHEET A3